

jura[®]



IMPRESSA F50 / F505

Instructions for use

Legend:

■ **DISPLAY** DISPLAY: serves as information.

■ **DISPLAY** DISPLAY: please follow the instructions shown.

 = Note / Tip

 = Important

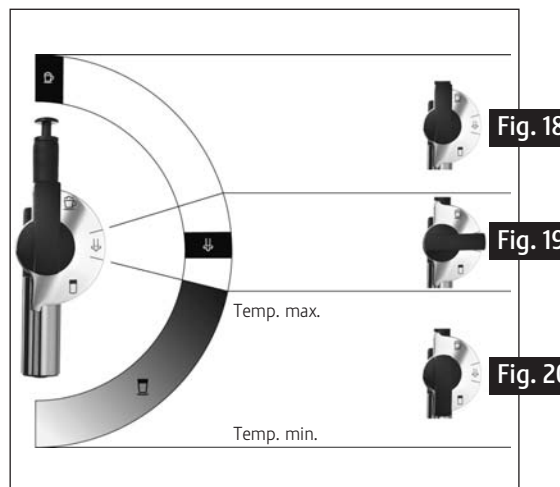
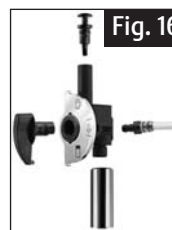
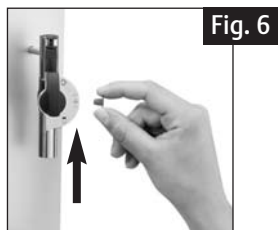
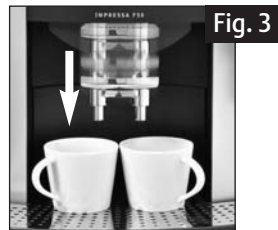
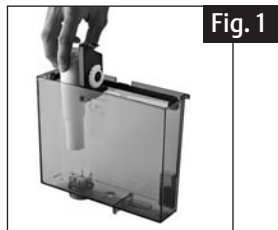

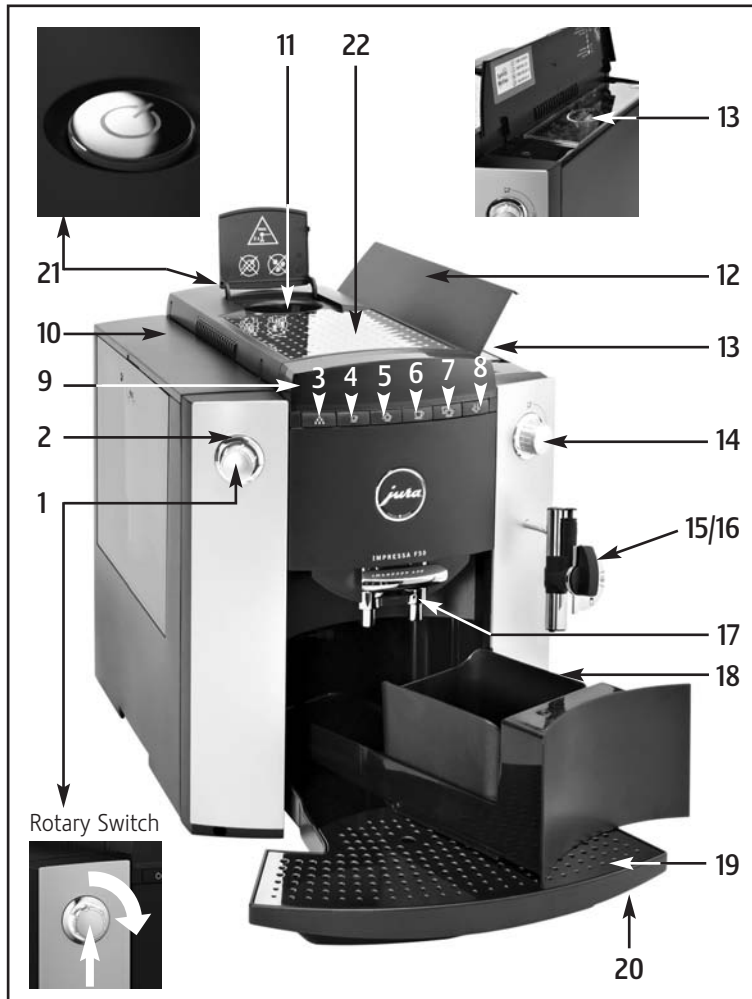

Control elements

1. Rotary Switch
2. Illuminated ring
3. Maintenance button
4. Preparation button, 1 espresso
5. Preparation button, 2 espressi
6. Preparation button, 1 coffee
7. Preparation button, 2 coffees
8. Steam preselection button
9. Display dialogue system
10. Water tank with handle
11. Filler funnel for preground coffee
12. Bean container cover
13. Aroma preservation cover
14. Steam / hot water draw-off tap
15. Removable Professional Cappuccino Frother with milk pipe
16. Removable hot-water nozzle (see Fig. 5)
17. Height-adjustable coffee spout
18. Coffee grounds container
19. Cup grille
20. Drip tray
21. On/Off button (= Zero-Energy Switch)
22. Metal shelf

Table of contents

1. Safety instructions	page 6	14. Switching off the IMPRESSA.....	page 17
1.1 Proper use	page 6	15. Programming.....	page 17
1.2 Warnings.....	page 6	15.1 Buttons programme item	page 19
1.3 Precautions	page 6	15.2 Filter programme item.....	page 20
2. Preparing the IMPRESSA.....	page 7	15.3 Water hardness programme item.....	page 20
2.1 Checking the mains voltage	page 7	15.4 Energy programme item	page 20
2.2 Checking the electric fuse	page 7	15.5 Automatic switch-off time programme item.....	page 20
2.3 Filling the water tank.....	page 7	15.6 Rinse programme item	page 21
2.4 Filling with coffee beans.....	page 7	15.7 Reset programme item.....	page 21
2.5 Adjusting the grinder	page 7	15.8 Information programme item	page 22
3. Using for the first time.....	page 8	15.9 ML/OZ display programme item	page 23
4. Adjusting the water hardness	page 8	15.10 Language programme item.....	page 24
5. Using the CLARIS filter cartridge.....	page 9	16. Maintenance.....	page 24
5.1 Inserting the filter.....	page 9	16.1 Filling with water	page 24
5.2 Changing the filter	page 10	16.2 Emptying coffee grounds container	page 24
6. Rinsing the IMPRESSA.....	page 10	16.3 Drip tray missing	page 25
7. Adjusting the amount of water for coffee.....	page 11	16.4 Filling with coffee beans.....	page 25
8. Preparing 1 cup of coffee	page 11	16.5 Changing the filter	page 25
9. Preparing 2 cups of coffee.....	page 12	16.6 Cleaning the IMPRESSA.....	page 25
10. Preparing preground coffee	page 12	16.7 IMPRESSA calcification.....	page 25
11. Preparing hot water	page 13	16.8 General cleaning instructions	page 25
12. Preparing steam.....	page 13	16.9 Emptying the system	page 26
13. Professional Cappuccino Frother	page 14	17. Cleaning.....	page 26
13.1 Preparing cappuccino with the Professional Cappuccino Frother	page 14	18. Descaling.....	page 27
13.2 Preparing hot milk with the Professional Cappuccino Frother	page 15	19. Disposal	page 28
13.3 Rinsing the Professional Cappuccino Frother.....	page 16	20. Tips for a perfect coffee.....	page 29
13.4 Dismantling and rinsing the Professional Cappuccino Frother	page 16	21. Messages.....	page 30
13.5 Cleaning the Professional Cappuccino Frother	page 16	22. Problems	page 31
		23. Legal information	page 32
		24. Technical data	page 32



Before you get started

Congratulations on purchasing this IMPRESSA. To ensure that your IMPRESSA works smoothly, please read these instructions for use carefully and keep them as a future reference.

If you need more information or if you experience any problems which are not covered in enough detail in these instructions for use, please contact your local stockist or ourselves.



1. Safety instructions

1.1 Proper use

The machine is designed and intended for private domestic use. It should only be used for coffee preparation and to heat milk and water. Use for any other purpose will be deemed improper. JURA Elektroapparate AG cannot accept any responsibility for the consequences of improper use.

Before using the machine read these instructions for use thoroughly and completely and comply with the instructions they contain. Keep these instructions for use close to the machine and pass them on to the next user.

1.2 Warnings

- Children are not aware of the dangers which may arise when using electric appliances, so never leave children unattended near electric appliances.

- The IMPRESSA may only be operated by instructed persons.
- People, including children, who
 - do not have the physical, sensory or mental capabilities to use the machine safely or
 - are inexperienced or lack knowledge in how to use the machine safelymust be supervised by a responsible person when using it, or must be instructed in how to use it correctly.
- Never start up a defective IMPRESSA or an IMPRESSA with a damaged supply cable.
- In the event of signs of damage, for example if there is a smell of burning, unplug the machine immediately from the mains supply and contact JURA service.
- If the mains cable of this machine is damaged, it must be repaired either directly by JURA or by an authorised JURA service centre.
- Never repair or open the IMPRESSA yourself. Repairs and modifications to the machine may only be undertaken by authorised JURA service centres using genuine spare parts and accessories. The machine contains live parts. If opened, there is a danger of potentially fatal injury.
- Do not immerse the IMPRESSA in water.

1.3 Precautions

- Never subject the IMPRESSA to environmental influences (rain, snow, frost) and do not operate with wet hands.
- Place the IMPRESSA on a sturdy, horizontal surface resistant to any water leaks. Never place on hot or warm surfaces (hobs). Select a site out of reach of children.

- Be careful to ensure that the mains cable is not trapped and does not rub against sharp edges.
- Always remove the mains plug during long periods of absence (holidays etc.).
- Always remove the mains plug before cleaning.
- When removing the mains plug, never tug the supply cable or the IMPRESSA itself.
- The IMPRESSA is connected to the power supply by a supply cable. Make sure people can't trip over the supply cable, bringing down the IMPRESSA. Make sure children and pets cannot reach the machine.
- Never put the IMPRESSA or individual parts of it in the dishwasher.
- Install the IMPRESSA in a place where the air can circulate well to prevent it from overheating.

2. Preparing the IMPRESSA

2.1 Checking the mains voltage



The IMPRESSA is set to the right mains voltage by default. Check whether your mains voltage matches that stated on the rating plate on the underside of your IMPRESSA.

2.2 Checking the electric fuse



The IMPRESSA is rated for a current of 10 amps. Check whether a fuse for this rating is fitted.

2.3 Filling the water tank



Only top up with fresh, cold water. Never fill with milk, mineral water or other liquids.

- Remove the water tank and rinse it well with cold mains water (Fig. 4).
- Then fill the water tank and refit in the IMPRESSA. Be careful to ensure that the tank is correctly inserted and properly engaged.

2.4 Filling with coffee beans



To make sure you get lasting enjoyment from your machine and to avoid the need for repairs, please note that the grinder in your JURA coffee machine is not suitable for coffee beans that have been treated with additives (e.g. sugar) during or after roasting. Using coffee blends of this type may damage the grinder. Any resulting repair costs will not be covered by the warranty conditions.

- Fold the bean container cover (12) open and remove the aroma preservation cover (13).
- Remove any dirt or foreign objects from inside the bean container.
- Fill the bean container with coffee beans and close the cover.

2.5 Adjusting the grinder

You can adjust the grinder to suit the degree of roast of your coffee. Our recommendations:

- a light roast → a finer setting (the smaller the dots, the finer the grinding)
- a dark roast → a coarser setting (the larger the dots, the coarser the grinding)



Only use the switch to adjust the consistency of grind when the grinder is running.

- Open the bean container cover (12) and remove the aroma preservation cover (13).
- To adjust the consistency of grind, turn the switch to the desired position during the grinding operation (Fig. 2).

3. Using for the first time

- Fill the bean container with coffee beans (12).
- Switch your IMPRESSA on with the On/Off button  (21).
- **DISPLAY** SPRACHE
DEUTSCH
- The illuminated ring (2) is active.
- Turn the Rotary Switch (1) until the desired language appears on the display.
- Now confirm your selection by pressing the Rotary Switch (1).
- **DISPLAY** FILL
WATER TANK
- Remove the water tank (10) and fill with fresh water. Refit the water tank in your IMPRESSA.
- **DISPLAY** OPEN TAP
- Place receptacle under the Professional Cappuccino Frother (15) (Fig. 10).
- Now open the steam / hot water draw-off tap (14) (Fig. 13).
- **DISPLAY** SYSTEM
FILLING

- **DISPLAY** CLOSE TAP
- Close the steam / hot water draw-off tap (14).
- **DISPLAY** SYSTEM
FILLING
- **DISPLAY** HEATING
- **DISPLAY** PRESS
RINSE
- Press the Maintenance button  (3).
- The machine rinses.
- **DISPLAY** RINSING
- **DISPLAY** READY



If FILL BEANS appears on the display, again press any coffee preparation button. The grinder is not yet filled with coffee beans.



To get a really good crema you can individually adjust the height-adjustable coffee spout (17) to your cup sizes (Fig. 3).

4. Adjusting the water hardness



Water is heated in the IMPRESSA. Over time this will result in calcification and this is displayed automatically. The IMPRESSA must be set to the hardness of the water used. Use the test strips provided.



1° German hardness corresponds to 1.79° French hardness.



When the filter is activated, the water hardness programme item disappears.

The IMPRESSA is set to 16° dH by default. You can change this setting. Proceed as follows:

- **DISPLAY** READY
- Press and hold the Rotary Switch (1) until RINSE appears on the display.
- The illuminated ring (2) is active.
- Turn the Rotary Switch (1) until the following message appears on the display:
 - **DISPLAY** HARDNESS
- Now press the Rotary Switch (1) to enter the programme item.
- **DISPLAY** 16° dH
- Now turn the Rotary Switch (1) until the desired water hardness appears.
- For example **DISPLAY** 20° dH.
- Confirm the desired water hardness by pressing the Rotary Switch (1).
- **DISPLAY** OK
- **DISPLAY** HARDNESS
- Turn the Rotary Switch (1) until the following message appears on the display:
 - **DISPLAY** EXIT
- Now press the Rotary Switch (1) to exit programming mode.
- **DISPLAY** READY

5. Using the CLARIS filter cartridge

i If you use the CLARIS filter cartridge correctly, your automatic coffee machine no longer has to be descaled. The DE-SCALE programme item no longer appears.

5.1 Inserting the filter

- Press and hold the Rotary Switch (1) until RINSE appears on the display.
- The illuminated ring (2) is active.
- Turn the Rotary Switch (1) until the following message appears on the display:
 - **DISPLAY** FILTER –
- Press the Rotary Switch (1) again to enter this programme item.
- **DISPLAY** NO –
- Turn the Rotary Switch (1) until the following message appears on the display:
 - **DISPLAY** YES ✓
- Press the Rotary Switch (1) to activate the filter cartridge.
- **DISPLAY** OK
- **DISPLAY** INSERT
OPEN TAP
- Remove and empty the water tank (10).
- Fold up the filter holder. Insert the filter cartridge in the water tank, exerting slight pressure (Fig. 1).
- Close the filter holder until it audibly snaps into place.
- Fill the water tank with cold, fresh mains water and reinsert the tank.
- Place a sufficiently large receptacle (around 1 litre) under the Professional Cappuccino Frother (15) (Fig. 10).
- Open the steam / hot water draw-off tap (14) (Fig. 13).
- **DISPLAY** FILTER
RINSING

i You can interrupt rinsing of the filter at any time by closing the steam / hot water draw-off tap (14). To continue with filter rinsing, open the steam / hot water draw-off tap (14) again.

- **DISPLAY** CLOSE TAP
- Close the steam / hot water draw-off tap (14), your IMPRESSA will now heat up to coffee temperature.
- **DISPLAY** HEATING
- **DISPLAY** READY

i You have now activated the filter. In programming mode, the Water hardness programme item **DISPLAY** HARDNESS no longer appears.

5.2 Changing the filter



i After drawing off around 50 litres of water, the filter will cease to work. You will be prompted to change the filter. Please use the scale on the filter holder on the water tank to monitor how long the CLARIS filter cartridge has been in use (max. 2 months).

- **DISPLAY** READY
FILTER
- Press the Maintenance button  (3) until the following message appears:
- **DISPLAY** CHANGE
OPEN TAP
- Remove the water tank from the machine and empty it.
- Fold up the filter holder. Take out the old CLARIS filter cartridge and insert the new filter cartridge into the water tank, exerting slight pressure (Fig. 1).





- Close the filter holder until it audibly snaps into place.
- Fill the water tank with cold, fresh mains water and reinsert in the IMPRESSA.
- Place a sufficiently large receptacle (around 1 litre) under the Professional Cappuccino Frother (15) (Fig. 10) and open the steam / hot water draw-off tap (14) (Fig. 13).
- **DISPLAY** FILTER
RINSING
- **DISPLAY** CLOSE TAP
- Close the steam / hot water draw-off tap (14).
- **DISPLAY** HEATING
- **DISPLAY** READY

6. Rinsing the IMPRESSA

i If the IMPRESSA is switched off and has already cooled down, you are prompted to perform the rinse operation. A rinse operation is triggered automatically when shutting the coffee machine down.

- Switch your IMPRESSA on with the On/Off button  (21).
- **DISPLAY** HEATING
- **DISPLAY** PRESS
RINSE
- Press the Maintenance button  (3).
- **DISPLAY** RINSING
- **DISPLAY** READY

7. Adjusting the amount of water for coffee

-  The figure in ML is approximate and may vary from the actual amount.
-  The machine automatically doubles the amount of water programmed for the 2 espresso ☞ / 2 coffees ☞ preparation buttons.
-  You can also change the amount of water during operation. Turn the Rotary Switch (1) during the brewing operation until the desired ML figure appears on the display.
-  You can stop the drawing off of water prematurely by pressing any button.
-  It is easy to permanently adjust the amount of water for all speciality coffees, milk specialities and hot water to the cup size. As in the following example, adjust the amount of water or milk once and then this amount will be used each time you prepare this speciality coffee.

Example:

Permanent setting of amount of water for one espresso:

- **DISPLAY** READY
- Press the 1 ESPRESSO preparation button and hold down until the following message appears on the display.
- **DISPLAY** 1 ESPRESSO
- **DISPLAY** ENOUGH COFFEE ?
- Press the button again as soon as there is enough coffee in your cup.
- **DISPLAY** OK

- **DISPLAY** 1 ESPRESSO

- **DISPLAY** READY

8. Preparing 1 cup of coffee

 You can change the strength at any time before or during the grinding operation by turning the Rotary Switch (1). You can choose from 4 strengths (**DISPLAY** MILD / NORMAL / STRONG / XSTRONG).

 You can stop preparation at any time by pressing any preparation button.

- **DISPLAY** READY

- Place 1 cup under the height-adjustable coffee spout (17).

- Press the 1 coffee preparation button ☞ (6).

- **DISPLAY** 1 COFFEE

- The illuminated ring (2) is active.

- You can adjust the desired strength for the current coffee preparation by turning the Rotary Switch (1) during the grinding operation.

- **DISPLAY** 1 COFFEE

- **DISPLAY** ■■■□□□□□□□

- You can adjust the desired amount of water for the current coffee preparation by again turning the Rotary Switch (1) during the brewing operation.

- For example **DISPLAY** 100 ML.

- Turn the Rotary Switch (1) until the desired amount of water appears on the display.

- For example **DISPLAY** 110 ML.

■ **DISPLAY** ■■■□□□□□□□

■ Your speciality coffee is prepared.

■ **DISPLAY** 1 COFFEE

■ **DISPLAY** READY

9. Preparing 2 cups of coffee



The strength cannot be selected when preparing 2 cups of coffee. You automatically prepare 2 mild cups.



You can stop preparation prematurely by pressing any preparation button.

■ **DISPLAY** READY

■ Place 2 cups under the height-adjustable coffee spout (17).

■ Press the 2 coffees preparation button  (7).

■ **DISPLAY** 2 COFFEES

■ The illuminated ring (2) is active.

■ **DISPLAY** ■■■□□□□□□□

■ You can adjust the desired amount of water for the current coffee preparation by turning the Rotary Switch (1) during the brewing operation. The modified ML value relates to 1 cup.

■ For example **DISPLAY** 100 ML.

■ Turn the Rotary Switch (1) until the desired amount of water appears on the display.

■ For example **DISPLAY** 110 ML.

■ **DISPLAY** ■■■□□□□□□□

■ Your speciality coffee is prepared.

■ **DISPLAY** 2 COFFEES

■ **DISPLAY** READY

10. Preparing preground coffee



Never use water-soluble instant coffee or instant coffee. We would recommend always using powder from freshly ground coffee beans or preground, vacuum-packed coffee. Never add more than 2 portions of powder. The filler shaft is not designed for storage. Ensure that the preground coffee you are using is not ground too fine. This may block the system and the coffee will then only be dispensed in drips.



If you have added too little powder, the NOT ENOUGH PRE-GROUND message appears on the display. The IMPRESSA aborts the operation, ejects the preground coffee and resets the machine so that it is ready to brew coffee.



You can interrupt preparation prematurely by pressing any preparation button.

■ **DISPLAY** READY



■ Place 1 or 2 cups under the height-adjustable coffee spout (17).

■ Open the cover of the filler funnel for preground coffee (11).

■ **DISPLAY** FILL
PRE-GROUND

■ Place 1 or 2 level measuring spoons of preground coffee into the filler funnel for preground coffee (11) (Fig. 11) and close the cover.

■ **DISPLAY** SELECT
BUTTON

- Select the 1 coffee preparation button  (6) or 2 coffees preparation button  (7).
- **DISPLAY** 1 COFFEE
- **DISPLAY** ■■■□□□□□□□
- The illuminated ring (2) is active.
- By turning the Rotary Switch (1), you can individually select the amount of water for coffee:
- For example **DISPLAY** 110 ML.
- **DISPLAY** ■■■□□□□□□□
- Your speciality coffee is prepared.
- **DISPLAY** 1 COFFEE
- **DISPLAY** READY

11. Preparing hot water

 To obtain a perfect water flow, fit the removable hot water nozzle (Fig. 5). Do not change the removable hot-water nozzle (16) immediately after drawing off water because it will be hot and there will be a danger of burns.

 When drawing off water, sputtering may occur at the start. Avoid direct contact with the skin.

- **DISPLAY** READY
- Place a cup under the removable hot-water nozzle (16) (Fig. 5).
- Open the steam / hot water draw-off tap (14) (Fig. 13).
- The illuminated ring (2) is active.
- **DISPLAY** WATER
- **DISPLAY** ■■■□□□□□□□

- If necessary adjust the amount of water saved by turning the Rotary Switch (1).
- For example **DISPLAY** 200 ML.
- **DISPLAY** ■■■□□□□□□□
- Once the desired amount of water is reached, the following appears on the display:
- **DISPLAY** CLOSE TAP
- Close the steam / hot water draw-off tap (14).
- **DISPLAY** READY

 Due to the system design, some water may be released before the TAP is closed.

12. Preparing steam



 The steam function is used to prepare milk foam and hot milk and for cleaning the Professional Cappuccino Frother (15).

 If the optional 2-stage frothing nozzle is fitted, the steam function can be used to heat liquids and produce foam.

 Make sure that the nozzle is fitted correctly when preparing steam. If the nozzle becomes blocked with particles of milk residue or is incorrectly assembled, it may disengage and come off while the frother is in use.

 Due to the system design, some water will escape at first when steam is drawn off. However, this will not affect the result in any way.

 When drawing off , sputtering may occur at the start. The nozzle gets hot during operation. Avoid direct contact with the skin.

- **DISPLAY** READY
 - Press the steam preselection button ↕ (8).
 - **DISPLAY** HEATING
 - **DISPLAY** READY
 - Open the steam / hot water draw-off tap (14) (Fig. 13) to draw off steam.
 - The illuminated ring (2) is active.
 - **DISPLAY** STEAM
 - **DISPLAY** ■■■□□□□□□□
 - You can adjust the steam preparation time individually by turning the Rotary Switch (1) until the desired number of SEC appear on the display.
 - For example **DISPLAY** 25 SEC.
 - **DISPLAY** ■■■□□□□□□□
 - If you do not change the steam preparation time on the Rotary Switch (1), you prepare the saved amount of steam.
 - Once the amount of steam is reached, the following message appears on the display:
 - **DISPLAY** CLOSE TAP
 - Close the steam / hot water draw-off tap (14).
 - **DISPLAY** READY
-  The machine is ready to prepare steam for around 40 sec., then the machine is reset so that it is ready to brew coffee.
-  You can prematurely stop steam preparation at any time by closing the steam / hot water draw-off tap (13).

 Due to the system design, some steam may be released before the tap is closed. There is a danger of scalding.

13. Professional Cappuccino Frother

13.1 Preparing cappuccino with the Professional Cappuccino Frother

 Cappuccino is made up of one third espresso, one third warm milk and one third milk foam. The Professional Cappuccino Frother (15) is used for preparing the milk portion.

 When steam is drawn off, a negative pressure is created and this draws milk with the aid of the Professional Cappuccino Frother (15) and produces milk foam.

You can also heat up milk by turning the selector switch on the Professional Cappuccino Frother to the Milk position (Fig. 20).

 To avoid malfunctions, the Professional Cappuccino Frother (15) must be cleaned regularly.

 Make sure that the nozzle is fitted correctly. If the nozzle becomes blocked with particles of milk residue or is incorrectly assembled, it may disengage and come off while the frother is in use.

- When using for the first time, remove the protective cover from the Professional Cappuccino Frother (Fig. 6). The protective cover is used only during transport to protect the nozzle against contaminant ingress.

- Remove the milk pipe from the Welcome Pack and connect it to the Professional Cappuccino Frother.

- Insert the other end of the milk pipe into a milk carton or connect it to a milk container (Fig. 7).
- Place a cup under the Professional Cappuccino Frother (Fig. 7).

i The high-quality stainless steel container is a practical addition for all lovers of milk specialities. It keeps the milk cool throughout the day and is fully in keeping with the design of your IMPRESSA.

All original JURA accessories are available from stockists.

- Turn the selector switch on the Professional Cappuccino Frother to the Milk Foam position (Fig. 18).
- **DISPLAY** READY
- Press the steam preselection button  (8).
- **DISPLAY** HEATING
- **DISPLAY** READY
- Open the steam / hot water draw-off tap (Fig. 13) to draw off steam. The milk foam is prepared.
- The illuminated ring (2) is active.
- **DISPLAY** STEAM
- **DISPLAY** ■■■■■■■■■■
- You can adjust the steam preparation time individually by turning the Rotary Switch (1) until the desired number of SEC appear on the display.
- For example **DISPLAY** 25 SEC.
- **DISPLAY** ■■■■■■■■■■
- If you do not change the steam preparation time on the Rotary Switch (1), you prepare the saved amount of steam.

i Adjust the steam preparation time to suit the size of your cup.

- Once the amount of steam is reached, the following message appears on the display:

■ **DISPLAY** CLOSE TAP

- Close the steam / hot water draw-off tap (14).

■ **DISPLAY** READY

i The machine is ready to prepare steam for around 40 sec., then the machine is reset so that it is ready to brew coffee.

i You can prematurely stop steam preparation at any time by closing the steam / hot water draw-off tap (14).

 Due to the system design, some steam and milk may be released before the tap is closed. There is a danger of scalding.

- Now, move your cup with the milk foam under the coffee spout and draw off the desired speciality coffee (Fig. 8). Your cappuccino is ready.

13.2 Preparing hot milk with the Professional Cappuccino Frother

i Turn the selector switch on the Professional Cappuccino Frother to the Milk position (Fig. 20).

The operation for preparing hot milk is the same as that for preparing milk foam for a cappuccino (see chapter 13 'Preparing cappuccino with the Professional Cappuccino Frother').

13.3 Rinsing the Professional Cappuccino Frother



To ensure that the Professional Cappuccino Frother (15) works perfectly, you should rinse it with water after every milk preparation.



Your IMPRESSA will not prompt you to rinse the Professional Cappuccino Frother.

- **DISPLAY** READY
- Remove the milk pipe from the milk carton or the milk container.
- Fill a receptacle with fresh water and immerse the milk pipe in it.
- Place a receptacle under the Professional Cappuccino Frother and move the selector switch to the Milk foam or Milk position.
- Press the steam preselection button  (8).
- **DISPLAY** HEATING
- **DISPLAY** READY
- Open the steam / hot water draw-off tap (14) (Fig. 13) to draw off steam. The frother and milk pipe are rinsed.
- **DISPLAY** STEAM
- **DISPLAY** ■■■■■■■■■■
- Ignoring the CLOSE TAP display message, draw off steam until clean water runs out of the frother. Then close the steam / hot water draw-off tap (14).
- **DISPLAY** READY

13.4 Dismantling and rinsing the Professional Cappuccino Frother

- Carefully remove the Professional Cappuccino Frother (15) from your IMPRESSA by twisting slightly.
- Dismantle the Professional Cappuccino Frother (15) into its individual parts (Fig. 16).
- Rinse all frother parts thoroughly under running water.
- Re-assemble the frother and refit it on your IMPRESSA.

13.5 Cleaning the Professional Cappuccino Frother



To ensure that the Professional Cappuccino Frother (15) always works properly, you should clean it daily when you have been preparing milk foam or hot milk.



Your IMPRESSA will not prompt you to clean the Professional Cappuccino Frother.



JURA Cappuccino Cleaner is available from stockists.

- Place a receptacle under the Professional Cappuccino Frother (Fig. 9).
- Fill a second receptacle with 2.5 dl of fresh water and add a capful of JURA Cappuccino Cleaner.
- Immerse the milk pipe in the second receptacle with the JURA Cappuccino Cleaner (Fig. 9).
- **DISPLAY** READY
- Press the steam preselection button  (8).
- **DISPLAY** HEATING
- **DISPLAY** READY

- Open the steam / hot water draw-off tap (Fig. 13) to draw off steam.
- **DISPLAY** STEAM
- **DISPLAY** ■■■■■□□□□□□□□
- Ignoring the CLOSE TAP display message, draw off steam until the receptacle containing JURA Cappuccino Cleaner is empty. The Professional Cappuccino Frother and the milk pipe are cleaned.
- Close the steam / hot water draw-off tap.
- **DISPLAY** READY

i The machine is ready to prepare steam for around 40 sec., then the machine is reset so that it is ready to brew coffee.

- Fill the receptacle with 2.5 dl of fresh water. Immerse the milk pipe in the receptacle containing fresh water.

i When READY appears on the **DISPLAY**, press the steam pre-selection button  (8) again to ready the machine to prepare steam.

- Open the steam / hot water draw-off tap (Fig. 13) to draw off steam.
- Ignoring the CLOSE TAP display message, draw off steam until the receptacle containing fresh water is empty. Then close the steam / hot water draw-off tap (14). The Professional Cappuccino Frother (15) and the milk pipe are rinsed with fresh water.
- Cleaning of the Professional Cappuccino Frother is complete, your IMPRESSA is ready for use.

14. Switching off the IMPRESSA

- **DISPLAY** READY
- Switch the IMPRESSA off with the On/Off button  (21).
- **DISPLAY** RINSING
- Automatic switch-off rinse is started.

i Just one automatic rinse is started if at least 1 speciality coffee has been prepared. Otherwise the machine switches off without a rinse.

15. Programming

i The IMPRESSA is configured in the factory such that you can prepare coffee without any additional programming. You can individually program various settings to adapt your beverages to your personal taste.

You can program the following settings:

- RINSE
- BUTTONS
- FILTER –
- HARDNESS
- ENERGY –
- OFF AFTER
- RINSING
- RESET
- INFO
- DISPLAY
- LANGUAGE





Rotary Switch

Permanent settings in programming mode always follow the same model. To enter programming mode, press the Rotary Switch (1) until RINSE appears on the display. By turning the Rotary Switch (1) you can change the set values and select different programme items. By pressing the Rotary Switch (1) you can view values or save selected values.

You can select and adapt the following programme items to your needs:

Programme item	Sub-item	Explanation
RINSE	RINSE FILTER (only appears if filter is activated) CLEAN DE-SCALE (only appears if filter is not activated) EXIT	Select the desired maintenance programme. If no action is taken, programming mode is exited automatically after approximately five seconds. For more information, please refer to chapters 6 and 16 to 18.
BUTTONS	SELECT BUTTON EXIT	Select your settings for speciality coffees, milk specialities and hot water.
FILTER $\text{--}/\checkmark$	NO -- YES \checkmark	Indicate whether you want to operate your IMPRESSA with or without a CLARIS filter cartridge.
HARDNESS (only appears if filter is not activated)	INACTIVE 1° – 30° dH	Adjust the water hardness.
ENERGY $\text{--}/\checkmark$	SAVE -- SAVE \checkmark	Select an energy-saving mode.

Programme item	Sub-item	Explanation
OFF AFTER	15 MIN to 15 HRS	Set the number of hours after which the IMPRESSA should switch off automatically.
RINSING	MANUAL AUTOMATIC	Set whether the switch-on rinse should be started manually or automatically.
RESET	PRODUCT ALL PROD. RESET ALL EXIT	Reset the settings for individual products, all products or the entire machine to the factory setting.
INFO	BUTTONS CLEAN FILTER (only appears if filter is activated) DE-SCALE (only appears if filter is not activated) VERSION EXIT	Keep track of all prepared speciality coffees and milk specialities and view the maintenance status.
DISPLAY	ML OZ	Select the unit for the amount of water.
LANGUAGE	DEUTSCH ENGLISH FRANCAIS ITALIANO NL ESPAÑOL PORTUGUES РУССКИЙ	Select your language.

15.1 Buttons programme item

i With the **DISPLAY** BUTTONS programme item you can enter individual settings for all speciality coffees, milk and hot water.

i Permanent settings in programming mode always follow the same model.

The following permanent settings can be made for speciality coffees, milk and hot water:

Product	Amount of water	Strength	Temperature
1 espresso	25 ML – 240 ML	MILD, NORMAL, STRONG, XSTRONG	NORMAL, HIGH
2 espressi	25 ML – 240 ML		NORMAL, HIGH
1 coffee	25 ML – 240 ML	MILD, NORMAL, STRONG, XSTRONG	NORMAL, HIGH
2 coffees	25 ML – 240 ML		NORMAL, HIGH
Milk	3 – 120 SEC		
Hot water	25 ML – 450 ML		

For example:

Proceed as follows to change the amount of water for a coffee from 100 ML to 110 ML, to change the strength from NORMAL to STRONG and the temperature from NORMAL to HIGH.

- Press the Rotary Switch (1) until the following message appears on the display:
 - **DISPLAY** RINSE
- Turn the Rotary Switch (1) again until the following message appears on the display:
 - **DISPLAY** BUTTONS
- Press the Rotary Switch (1).
- **DISPLAY** SELECT
BUTTON

- Press the preparation button for the speciality coffee for which you want to adjust the amount of water. For example, 1 COFFEE.
- **DISPLAY** WATER
- Press the Rotary Switch (1).
- For example **DISPLAY** 100 ML.
- Turn the Rotary Switch (1) to adjust the amount of water as desired.
- For example **DISPLAY** 110 ML.
- Press the Rotary Switch (1) to save the new amount of water.
- **DISPLAY** OK
- **DISPLAY** WATER
- Turn the Rotary Switch (1) further until the next sub-item appears on the display:
 - **DISPLAY** STRENGTH
- Press the Rotary Switch (1).
- **DISPLAY** NORMAL
- Turn the Rotary Switch (1) until the following message appears on the display:
 - **DISPLAY** STRONG
- Press the Rotary Switch (1) to save the change.
- **DISPLAY** OK
- **DISPLAY** STRENGTH
- Turn the Rotary Switch (1) further until TEMPERATURE appears on the display.
- Press the Rotary Switch (1).
- **DISPLAY** NORMAL

- Turn the Rotary Switch (1) to adjust the temperature.
- **DISPLAY** HIGH
- Press the Rotary Switch to confirm your selection.
- **DISPLAY** OK
- **DISPLAY** TEMP.
- Turn the Rotary Switch (1) until EXIT appears on the display.
- Press the Rotary Switch (1).
- **DISPLAY** SELECT
BUTTON
- Turn the Rotary Switch (1) again until EXIT appears on the display.
- Press the Rotary Switch (1).
- **DISPLAY** BUTTONS
- Turn the Rotary Switch (1) again until EXIT appears on the display.
- Press the Rotary Switch (1) to exit programming mode.
- **DISPLAY** READY



15.2 Filter programme item

For details, please refer to chapter 5.1 'Inserting the filter'.

15.3 Water hardness programme item

For details, please refer to chapter 4 'Adjusting the water hardness'.

15.4 Energy programme item

 The IMPRESSA is equipped with the new On/Off button  (21) (= Zero-Energy Switch). This allows the machine to be fully disconnected from the mains. An Energy Save Mode (E.S.M.®) can also be permanently set.

- **DISPLAY** READY
- Press and hold the Rotary Switch (1) until RINSE appears on the display.
- The illuminated ring (2) is active.
- Turn the Rotary Switch (1) until ENERGY – appears on the display.
- Press the Rotary Switch (1).
- **DISPLAY** SAVE –
- Turn the Rotary Switch (1) until the following message appears on the display:
- **DISPLAY** SAVE ✓
- Press the Rotary Switch (1) again to confirm the change.
- **DISPLAY** OK
- **DISPLAY** ENERGY ✓
- Turn the Rotary Switch (1) until EXIT appears on the display.
- Press the Rotary Switch (1) to exit programming mode.
- **DISPLAY** READY

15.5 Automatic switch-off time programme item

 You can program when your IMPRESSA is to switch off. Select a time between 15 min. and 15 hrs.

- **DISPLAY** READY

- Press and hold the Rotary Switch (1) until RINSE appears on the display.
- The illuminated ring (2) is active.
- Press the Rotary Switch (1) until you reach the OFF AFTER programme item.
- **DISPLAY** OFF AFTER
- Press the Rotary Switch (1) to enter the OFF AFTER programme item.
- **DISPLAY** 1 HRS
- Turn the Rotary Switch (1) to set the number of hours after which the machine is to switch off.
- For example **DISPLAY** 2 HRS.
- Press the Rotary Switch (1) to save the new automatic switch-off time.
- **DISPLAY** OK
- **DISPLAY** OFF AFTER
- Turn the Rotary Switch (1) until the following message appears on the display.
- **DISPLAY** EXIT
- Press the Rotary Switch (1) again to exit programming mode.
- **DISPLAY** READY

15.6 Rinse programme item

 You can set whether the rinse should be started manually or automatically when switching on.

- **DISPLAY** READY

- Press and hold the Rotary Switch (1) until RINSE appears on the display.
- The illuminated ring (2) is active.
- Turn the Rotary Switch (1) until RINSING appears on the display.
- Press the Rotary Switch (1).
- **DISPLAY** MANUAL
- Turn the Rotary Switch (1) until the following message appears on the display:
- **DISPLAY** AUTOMATIC
- Press the Rotary Switch (1) again to confirm the change.
- **DISPLAY** OK
- **DISPLAY** RINSING
- Turn the Rotary Switch (1) until EXIT appears on the display.
- Press the Rotary Switch (1) to exit programming mode.
- **DISPLAY** READY

15.7 Reset programme item

 In the RESET programme item you can reset various settings to their factory settings:

- **DISPLAY** PRODUCT
The settings (amount of water, strength, temperature) for any product can be reset individually to the factory settings. The corresponding double product is reset to the factory settings at the same time.
- **DISPLAY** ALL PROD.
The settings (amount of water, strength, temperature) for all products are reset to the factory settings.

■ **DISPLAY** RESET ALL

All customer settings are reset to the factory settings. The IMPRESSA then switches off.

For example you want to reset the values for one product to the factory setting:

■ **DISPLAY** READY

■ Press and hold the Rotary Switch (1) until RINSE appears on the display.

■ The illuminated ring (2) is active.

■ Turn the Rotary Switch (1) until RESET appears on the display.

■ Press the Rotary Switch (1).

■ **DISPLAY** PRODUCT

■ Press the Rotary Switch (1).

■ **DISPLAY** SELECT
BUTTON

■ Press any preparation button, e.g. 1 ESPRESSO.

■ **DISPLAY** OK

■ **DISPLAY** SELECT
BUTTON

 By again pressing the appropriate preparation button, you can reset other speciality coffees to their factory setting.

■ **DISPLAY** SELECT
BUTTON

■ Press the Rotary Switch (1) to exit the PRODUCT programming item.

■ Turn the Rotary Switch (1) until EXIT appears on the display.

■ Press the Rotary Switch (1).

■ **DISPLAY** RESET

■ Turn the Rotary Switch (1) again until EXIT appears on the display.

■ Press the Rotary Switch (1) to exit programming mode.

■ **DISPLAY** READY

15.8 Information programme item

 In the INFORMATION programme item you can view the following information:

- Total coffee preparations
- Number of speciality coffees prepared, number of ‘coffee powder’, ‘hot water’ and ‘steam’ preparations
- Maintenance status and number of maintenance programmes performed (cleaning, descaling, changing the filter)
- and information relating to the software version

■ **DISPLAY** READY

■ Press and hold the Rotary Switch (1) until RINSE appears on the display.

■ The illuminated ring (2) is active.

■ Turn the Rotary Switch (1) until INFO appears on the display.

■ Press the Rotary Switch (1).

■ **DISPLAY** BUTTONS

■ Press the Rotary Switch (1) again.

■ **DISPLAY** XXXX (=total number of speciality coffees prepared).

 To view the number of product preparations, press the preparation button of the desired speciality coffee. For example, to view the number of ‘1 COFFEE’ preparations.

- Press the 1 COFFEE preparation button.
- **DISPLAY** XXXX (=total number for '1 COFFEE')
- Press the Rotary Switch (1) to exit the programme item.
- **DISPLAY** BUTTONS

i Turn the Rotary Switch (1) for more information about the filter, descaling or the machine version.

- Turn the Rotary Switch (1) until CLEAN appears on the display for example.
- Press the Rotary Switch (1) to view the number of cleaning operations performed.
- **DISPLAY** XXXX (=total number of cleaning operations performed)
- Turn the Rotary Switch (1) until the following message appears on the display:
- **DISPLAY** ■■■■■■■■■■

i In addition to the number of maintenance programmes performed, the progress bar also shows you the current maintenance status. When the bar is completely filled, your IMPRESSA will request the respective maintenance programme.

- Press the Rotary Switch (1) to exit the CLEAN programme item.
- **DISPLAY** CLEAN
- Turn the Rotary Switch (1) until EXIT appears on the display.
- Press the Rotary Switch (1).
- **DISPLAY** INFO
- Turn the Rotary Switch (1) again until EXIT appears on the display.

- Press the Rotary Switch (1) again.
- Press the Rotary Switch (1) once more.
- **DISPLAY** READY

15.9 ML/OZ display programme item

- **DISPLAY** READY
- Press and hold the Rotary Switch (1) until RINSE appears on the display.
- The illuminated ring (2) is active.
- Turn the Rotary Switch (1) until DISPLAY appears on the **DISPLAY**.
- Press the Rotary Switch (1).
- **DISPLAY** ML
- Turn the Rotary Switch (1) and select the desired setting.
- For example **DISPLAY** OZ.
- Press the Rotary Switch (1) to save the desired setting.
- **DISPLAY** OK
- **DISPLAY** DISPLAY
- Turn the Rotary Switch (1) until the following message appears on the display:
- **DISPLAY** EXIT
- Press the Rotary Switch (1) to exit programming mode.
- **DISPLAY** READY

15.10 Language programme item

 You can choose from the following languages:

German	Dutch
English	Spanish
French	Portuguese
Italian	Russian

- **DISPLAY** READY
- Press and hold the Rotary Switch (1) until RINSE appears on the display.
- The illuminated ring (2) is active.
- Turn the Rotary Switch (1) until you reach the LANGUAGE programme item.
- **DISPLAY** LANGUAGE
- Press the Rotary Switch (1) to enter the LANGUAGE programme item.
- **DISPLAY** ENGLISH
- Turn the Rotary Switch (1) until the desired language appears on the display.
- For example **DISPLAY** DEUTSCH.
- Press the Rotary Switch (1) to save the language selected.
- **DISPLAY** OK
- **DISPLAY** SPRACHE
- Turn the Rotary Switch (1) until the following message appears on the display:
 - **DISPLAY** EXIT
- Press the Rotary Switch (1) to exit programming mode.
- **DISPLAY** BEREIT

16. Maintenance

16.1 Filling with water

- **DISPLAY** FILL
WATER TANK

 When this display lights up, the machine cannot prepare any more products. Top up with water as described in chapter 2.3.

- **DISPLAY** READY

 The water tank should be rinsed daily and filled with fresh water. Only top up with fresh, cold water. Never fill with milk, mineral water or other liquids.

16.2 Emptying coffee grounds container

- **DISPLAY** EMPTY
GROUNDS



 When this display lights up, the machine cannot prepare any more products and the coffee grounds container must be emptied (Fig. 14).

- Remove the drip tray (20) carefully as it will contain water.
- **DISPLAY** TRAY
MISSING
- Fit the empty, clean drip tray back in the IMPRESSA.
- **DISPLAY** READY

16.3 Drip tray missing

- **DISPLAY** TRAY
MISSING
- When this display lights up, the drip tray (20) has not been correctly inserted or has not been inserted at all.
- Insert the drip tray (20).
- **DISPLAY** READY

16.4 Filling with coffee beans

- **DISPLAY** FILL
BEANS
- Top up the beans as described in chapter 2.4.
-  The FILL BEANS display only goes out after a coffee has been prepared.
-  We recommend that you clean the bean container with a dry cloth from time to time before refilling. Switch the IMPRESSA off to do this.

16.5 Changing the filter

-  After drawing off 50 litres of water, the filter will cease to work. You will be prompted to change the filter.

For details, please refer to chapter 5.2 'Changing the filter'.

16.6 Cleaning the IMPRESSA

After 200 preparations or 160 rinses, the IMPRESSA must be cleaned. The display will indicate this. You can still prepare coffee or hot water/steam. We do however recommend that you undertake cleaning within the next couple of days. For details, please refer to the cleaning chapter (item 17).

- **DISPLAY** READY
CLEAN

16.7 IMPRESSA calcification

Over time the IMPRESSA will build up limescale deposits. The degree of calcification depends on the hardness of your water. The IMPRESSA detects when it needs descaling. You can still prepare coffee or hot water/steam. We do however recommend that you undertake descaling within the next couple of days. For details, please refer to the descaling chapter (item 18).

- **DISPLAY** READY
DE-SCALE

16.8 General cleaning instructions

- When cleaning never use objects, pan cloths or cleaning sponges which may scratch the machine or corrosive chemicals.
- Wipe the inside and outside of the housing with a soft, damp cloth.
- Always clean the removable hot-water nozzle after use.
- To ensure that the Professional Cappuccino Frother always works properly, you should rinse it with water after every milk preparation.



- To ensure that the Professional Cappuccino Frother always works properly, you should clean it daily when you have been preparing milk.
- The water tank should be rinsed daily and filled with fresh water.

i If you can see scale starting to form in the water tank, you can use a conventional descaling agent to remove it. Remove the water tank to do this (Fig. 4).

i When using a Claris filter cartridge, remove this before descaling the tank.

16.9 Emptying the system

i This operation is needed to protect the IMPRESSA from frost damage during transport.

- **DISPLAY** READY
- Press the steam preselection button  (8).
- **DISPLAY** HEATING
- **DISPLAY** READY
- Open the steam / hot water draw-off tap (14) (Fig. 13) to draw off steam.
- The illuminated ring (2) is active.
- **DISPLAY** STEAM
- **DISPLAY** 
- Remove and empty the water tank. Allow all the steam to exit the nozzle until the system is empty.
- **DISPLAY** CLOSE TAP

- Close the steam / hot water draw-off tap (14).
- Press the On/Off button  (21) to switch off your IMPRESSA.

17. Cleaning



The IMPRESSA machine comes with an integrated Cappuccino cleaning programme. The operation lasts about 15 minutes.

i Your stockist can supply original JURA cleaning tablets which are optimised for the cleaning programme of your IMPRESSA. We would like to point out that using unsuitable cleaning tablets may damage your machine and leave traces in the water.

i Once started, the cleaning operation must not be interrupted.

i The filler funnel for preground coffee must be cleaned after every cleaning programme (11).

- **DISPLAY** READY
CLEAN
- Press the Maintenance button  (3) until the following message appears:
- **DISPLAY** EMPTY
TRAY
- Empty the drip tray.
- **DISPLAY** TRAY
MISSING
- Carefully reinsert the drip tray.
- Remove the cup grille (19).

- Place a 1 litre receptacle (Fig. 12) under the height-adjustable coffee spout (17).
- **DISPLAY** PRESS
RINSE
- Press the Maintenance button  (3).
- **DISPLAY** CLEANING
- **DISPLAY** ADD
TABLET
- Add the tablet to the powder shaft (Fig. 15). Close the powder shaft.
- **DISPLAY** PRESS
RINSE
- Press the Maintenance button  (3).
- **DISPLAY** CLEANING
- **DISPLAY** EMPTY
TRAY
- Remove and empty the drip tray.
- **DISPLAY** TRAY
MISSING
- Reinsert the drip tray.
- **DISPLAY** HEATING
- **DISPLAY** READY
- Once the cleaning operation is complete, use a dry cloth to rub down the powder shaft.
- Cleaning is complete.

18. Descaling

The IMPRESSA machine comes with an integrated descaling programme. The operation lasts about 40 minutes.

 Your stockist can supply original JURA descaling tablets which are optimised for the descaling programme of your IMPRESSA. We would like to point out that using unsuitable descaling tablets may damage your machine and leave traces in the water.

 The display will indicate when the IMPRESSA needs descaling. You can still prepare coffee or hot water/steam and run the descaling programme later on. Once started, the descaling operation must not be interrupted.

 When using the descaling agent, immediately clean up any splashes or drips on sensitive surfaces, especially natural stone and wooden surfaces. Alternatively take appropriate precautions.

 Always wait until all the added descaling agent has been used and the tank is empty. Never top up the descaling agent.

- **DISPLAY** READY
DE-SCALE
- Remove the Professional Cappuccino Frother (15) (Fig. 17).
- Press the Maintenance button  (3) until the following message appears:
- **DISPLAY** EMPTY
TRAY
- Empty the drip tray.

- **DISPLAY** TRAY
MISSING

■ Carefully reinsert the drip tray.

- **DISPLAY** AGENT
IN TANK

Remove and empty the water tank. Completely dissolve the contents of one blister (3 tablets) in 0.5 litres of water and add the mixture to the water tank. Reinsert the water tank.

- **DISPLAY** OPEN TAP
AGENT
IN TANK

■ Place a sufficiently large receptacle under the hot-water spout (Fig. 17).

■ Open the steam / hot water draw-off tap (14) (Fig. 13).

- **DISPLAY** DE-SCALING

- **DISPLAY** CLOSE TAP

■ Close the steam / hot water draw-off tap (14).

- **DISPLAY** DE-SCALING

- **DISPLAY** EMPTY
TRAY

■ Empty the drip tray.

- **DISPLAY** TRAY
MISSING

■ Carefully reinsert the drip tray.

- **DISPLAY** FILL
WATER TANK



Rinse the water tank thoroughly and fill it with cold fresh mains water. Then refill in the IMPRESSA.

- **DISPLAY** OPEN
TAP

■ Open the steam / hot water draw-off tap (14) (Fig. 13).

- **DISPLAY** DE-SCALING

- **DISPLAY** CLOSE TAP

■ Once you have closed the steam / hot water draw-off tap (14), the following appears on the display:

- **DISPLAY** DE-SCALING

- **DISPLAY** EMPTY
TRAY

■ Empty the drip tray.

- **DISPLAY** TRAY
MISSING

■ Carefully reinsert the drip tray.

- **DISPLAY** READY

■ Descaling is complete.

19. Disposal



Please dispose of old machines in an environmentally-neutral way

Old machines contain valuable, recyclable materials which should be recycled. Please therefore dispose of old machines via suitable collection systems.

20. Tips for a perfect coffee

Height-adjustable coffee spout (17)

You can adjust the coffee spout to the size of your cups (Fig. 3).

Consistency of grind

For details, please refer to chapter 2.5 'Adjusting the grinder'

Prewarming cups

You can prewarm the cups with hot water or steam. The smaller the amount of water for coffee, the more important the prewarming process.

Sugar and cream

Heat will be lost when you stir the product in your cup. Adding cream or milk from the fridge greatly lowers the temperature of the coffee.

21. Messages

DISPLAY	Cause	Remedy
FILL WATER TANK	The water tank is empty	Fill the water tank
	The float is defective	Rinse or descale the water tank
FILL BEANS	The bean container is empty	Fill with beans
	Even though the beans have been topped up, the display does not go out	Prepare a cup of coffee. The Fill beans message only disappears after you have prepared a coffee
EMPTY GROUNDS	Coffee grounds container full	Empty coffee grounds container
	Drip tray inserted too soon after emptying	Wait 10 sec. before inserting drip tray
TRAY MISSING	Drip tray not inserted correctly or missing	Insert correctly
READY CLEAN	Cleaning needed	Perform cleaning operation (chapter 17)
READY DE-SCALE	Descaling needed	Perform descaling operation (chapter 18)
READY FILTER	Filter has ceased working	Change filter (chapter 5.2)
ERROR	General fault	- Disconnect IMPRESSA from mains
		- Have IMPRESSA checked by JURA customer support
		- You will find contact details for your country at www.jura.com .

22. Problems

Problem	Cause	Remedy
Very loud grinder noise	Foreign object in grinder	Coffee preparation with preground powder still possible Have IMPRESSA checked by JURA customer support
Too little foam when producing milk foam	Professional Cappuccino Frother is dirty	Clean the Professional Cappuccino Frother (chapter 13)
	Individual parts of Professional Cappuccino Frother are not correctly assembled	Check how the Professional Cappuccino Frother is put together
Coffee only dispensed in drips	Consistency of grind too fine	Adjust grinder to coarser setting
	Preground coffee too fine	Use a coarser preground coffee

High-frequency electromagnetic interference may affect the display. Coffees can be still prepared.

If you have not been able to remedy messages or problems, please contact your stockist or JURA Elektroapparate AG.

23. Legal information

These instructions for use contain the information required to correctly use, operate and maintain the machine.



The information in these instructions for use must be read and followed to ensure safe usage, operation and maintenance.

These instructions for use cannot take into account every conceivable form of use. The machine is designed for private use at home.

We would also like to inform you that the content of these instructions for use does not form part of a previous or existing agreement, undertaking or legal relationship or change any which do exist. All the obligations of JURA Elektroapparate AG can be found in the respective purchase agreement which also contains the complete and only warranty agreement. These contractual warranty provisions are neither extended nor restricted by the details provided in these instructions for use.

The instructions for use contain information which is protected by copyright. It is not permitted to photocopy these instructions for use or translate them into another language without the prior written consent of JURA Elektroapparate AG.

24. Technical data

Voltage:	220 – 240 V ~, 50 Hz
Power:	1450 W
Current:	10 A
SAVE – energy consumption:	Approx. 18 Wh
SAVE ✓ energy consumption:	Approx. 5 Wh
Pump pressure:	Static, max. 15 bar
Water tank:	1.9 litres
Holding capacity of bean container:	200 g
Holding capacity of coffee grounds container:	Max. 16 portions
Cable length:	Approx. 1.1 m
Weight:	9.1 kg
Dimensions (WxHxD):	28 x 34.5 x 44.5 cm
Marks of conformity:	 

JURA Elektroapparate AG in Niederbuchsiten confirms that its automatic coffee machines comply with the following directives.

This machine complies with the following directives:

2006 / 95 / EC – Low-Voltage Directive

2004 / 108 / EC – Electromagnetic Compatibility

2005 / 32 / EC – Ecodesign

jura[®]

JURA Elektroapparate AG – Kaffeeweltstrasse 10 – CH-4626 Niederbuchsiten
Phone +41 62 389 82 33 – Fax +41 62 389 83 94 – www.jura.com

IMPRESSA
IF YOU LOVE COFFEE